

PP HT NORDIC ĒKU KANALIZĀCIJAS SISTĒMA

NOSAUKUMS	IZMĒRS	IEPAK.	KODS
-----------	--------	--------	------

CAURULE AR UZMAVU



	D _a (mm)	s (mm)	L (m)	gab.		
32	32	1.8	1.8	0.25	30/1440	080000
				0.5	105	080002
				1	10/200	080003
				2	10/200	080005
40	40	1.8	1.8	0.25	50	080020
				0.5	60	080022
				1	10/200	080023
				2	10/200	080025
50	50	1.8	1.8	0.25	25/600	080030
				0.5	35/420	080032
				1	80	080033
				2	80	080035
50	50	1.8	1.8	0.25	25/600	070030
				0.5	35/420	070032
				1	80	070033
				2	80	070035
75	75	2.7	2.7	0.25	35/280	070040
				0.5	25/200	070042
				1	72	070043
				2	72	070045
110	110	2.7	2.7	0.25	20/160	070060
				0.5	96	070062
				1	54	070063
				2	54	070065

koda otrais skaitlis norāda krāsu: 8-BALTS, 7-PELĒKS

TREJGABALS



	D _a (mm)	D _a (mm)	leņķis	gab.	
32	32	32	45°	70/1680	180001
			88°	70/1680	180081
40	40	40	45°	50/1200	180002
			88°	25/1200	180082
50	50	50	45°	30/720	180004
			88°	35/840	180084
50	50	50	45°	30/720	170004
			88°	35/840	170084
75	75	75	45°	25/300	170007
			88°	30/360	170087
			45°	20/240	170008
			88°	25/300	170088
110	110	110	45°	25/200	170016
			88°	25/200	170096
			45°	15/120	170017
			88°	20/160	170097
			45°	12/96	170019
			88°	15/120	170099

koda otrais skaitlis norāda krāsu: 8-BALTS, 7-PELĒKS

DUBULTUZMAVA



D(mm)	gab.	
32	60/2880	180511
40	30/1440	180512
50	20/960	180513
50	20/960	170513
75	25/600	170514
110	20/240	170516

koda otrais skaitlis norāda krāsu: 8-BALTS, 7-PELĒKS

PP HT NORDIC ĒKU KANALIZĀCIJAS SISTĒMA

NOSAUKUMS	IZMĒRS	IEPAK.	KODS
-----------	--------	--------	------

LĪKNIS



	D _a (mm)	leņķis		gab.	
		leņķis	gab.		
32		15°	70/3360	180301	
		30°	70/3360	180321	
		45°	70/3360	180331	
		67°	70/3360	180341	
		88°	70/3360	180361	
40		15°	40/1920	180302	
		30°	40/1920	180322	
		45°	40/1920	180332	
		67°	40/1920	180342	
		88°	40/1920	180362	
50		15°	30/1440	180303	
		30°	30/1440	180323	
		45°	30/1440	180333	
		67°	25/1200	180343	
		88°	25/1200	180363	
50		15°	30/1440	170303	
		30°	30/1440	170323	
		45°	30/1440	170333	
		67°	25/1200	170343	
		88°	25/1200	170363	
75		15°	25/600	170304	
		30°	25/600	170324	
		45°	25/600	170334	
		67°	20/480	170344	
		88°	20/480	170364	
110		15°	20/240	170306	
		30°	20/240	170326	
		45°	30/240	170336	
		67°	25/200	170346	
		88°	25/200	170366	

koda otrais skaitlis norāda krāsu: 8-BALTS, 7-PELĒKS

KRUSTGABALS



	D _a (mm)	D _a (mm)	leņķis		gab.	
			leņķis	gab.		
110		110	45°	7/56	170139	
			88°	9/72	170219	

REVĪZIJA AR VĀKU



	D(mm)		gab.	
	D(mm)	gab.		
50		20/480	180463	
75		25/300	170464	
110		18/144	170466	

koda otrais skaitlis norāda krāsu: 8-BALTS, 7-PELĒKS

LABOŠANAS DUBULTUZMAVA



	D(mm)		gab.	
	D(mm)	gab.		
32		60/2880	180521	
40		30/1440	180522	
50		20/960	180523	
50		30/1440	170523	
75		34/816	170524	
110		20/240	170526	

koda otrais skaitlis norāda krāsu: 8-BALTS, 7-PELĒKS

PP HT NORDIC ĒKU KANALIZĀCIJAS SISTĒMA

NOSAUKUMS	IZMĒRS	IEPAK.	KODS
-----------	--------	--------	------

UZMAVAS NOSLĒGTAPA



D(mm)	gab.	
32	100/9600	180471
40	100/4800	180472
50	80/3840	180473
50	60	170473
75	30/1440	170474
110	30/720	170476

koda otrais skaitlis norāda krāsu: 8-BALTS, 7-PELĒKS

GARĀ PĀREJA EKSCENTRISKA

(Redukcija: uzmava - caurule)



D _a (mm)		D _b (mm)	gab.	
40	/	32	50/2400	180601
	/	32	100/2400	180602
50	/	40	90/2160	180603
	/	40	90/2160	170603
	/	50	25/1200	180605
110	/	50	20/480	170608
	/	75	40/480	170609

koda otrais skaitlis norāda krāsu: 8-BALTS, 7-PELĒKS

ĪSĀ PĀREJA

(Redukcija: uzmava - caurule)

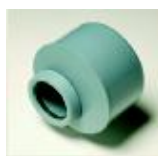

D _a (mm)		D _b (mm)	gab.	
40	/	32	60/2880	180580
	/	32	60/2880	180581
50	/	32	60/2880	170581
	/	40	30/2880	180582
75	/	50	32/1536	170585
110	/	50	30/720	170589
	/	75	20/480	170590

koda otrais skaitlis norāda krāsu: 8-BALTS, 7-PELĒKS

LABOŠANAS UZMAVA

(Pāreja: caurule - caurule)



D(mm)	gab.	
50	40/1920	180553
75	18/864	170554
110	30/480	170556

koda otrais skaitlis norāda krāsu: 8-BALTS, 7-PELĒKS

LABOŠANAS UZMAVA - REDUKCIJA

(Redukcija: uzmava - caurule)



D _a (mm)		D _b (mm)	gab.	
50	/	32	40/3840	180572
	/	32	40/1920	170574
75	/	50	40/1920	180575
	/	50	35	170577
110	/	75	30	170578

koda otrais skaitlis norāda krāsu: 8-BALTS, 7-PELĒKS



SLĪDSMĒRE

Svars(grami)	gab.	
50	20	181996
400	12	181997
1000	6	181998

PP HT NORDIC ĒKU KANALIZĀCIJAS SISTĒMA

NOSAUKUMS	IZMĒRS	IEPAK.	KODS
-----------	--------	--------	------

DUBULTUZMAVU LĪKNIS



	D _a (mm)	Iepak.	
		leņķis	gab.
32		15°	50/2400
		30°	50/2400
		45°	50/2400
		88°	40/1920
40		45°	30/1440
		88°	25/1200
50		45°	20/960
		88°	44/1056
75		45°	20/480
		88°	30/480
110		45°	30/240
		88°	20/160

koda otrais skaitlis norāda krāsu: 8-BALTS, 7-PELĒKS

DUBULTUZMAVU TREJGABALS



	D _a (mm)	D _a (mm)	Iepak.	
			leņķis	gab.
32			45°	50/1200
			88°	50/1200
40			45°	30/720
			88°	40/960
50			45°	20/480
			88°	25/600
75			45°	20/320
			88°	172007
			45°	20/320
			88°	172087
110			45°	25/200
			88°	172008
			45°	25/200
			88°	172088
			45°	20/160
			88°	172016
110			45°	20/110
			88°	172096
			45°	21/168
			88°	172017
110			45°	15/120
			88°	172097
110			45°	8/96
110			88°	10/80
110			88°	172019
110			88°	172099

koda otrais skaitlis norāda krāsu: 8-BALTS, 7-PELĒKS

SKAVA



D(mm)	Iepak.	
32	60/5760	180761
40	300/14400	180762
50	100/4800	180763
75	60/2880	170764
110	60/1440	170766

koda otrais skaitlis norāda krāsu: 8-BALTS, 7-PELĒKS

DEGMANŽETES

ĀRPUS PĀRSEGUMA MONTĒJAMĀ MANŽETE

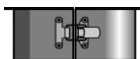

D(mm)	Iepak.	
50	1	180543
75	1	180544
110	1	180546
160	1	180548







*cenas pēc pieprasījuma

PĀRSEGUMĀ MONTĒJAMĀ MANŽETE



50	1	180539
75	1	180540
110	1	180541
160	1	180542

STILLA[®] skaņu absorbējoša kanalizācijas cauruļu sistēma PP HT

NOSAUKUMS	IZMĒRS	IEPAK.	KODS	
CAURULE AR UZMAVU	D _a (mm) s (mm) L (m)	gab.		
	50 1.8 3	126	071337	
	75 2.6 3	56	071347	
	110 3.8 3	40	071367	
	160 5.5 3	28	071387	
TREJGABALS 45°	D _a (mm) D _a (mm) lenķis	gab.		
	50 50 45°	25/600	184004	
	75 50 45°	15/360	184007	
	75 75 45°	32/256	184008	
	110 50 45°	20/160	184016	
	110 75 45°	15/120	184017	
	110 110 45°	12/96	184019	
	160 110 45°	8/48	184032	
	160 160 45°	5/30	184034	
TREJGABALS 90°	D _a (mm) D _a (mm) lenķis	gab.		
	50 50 90°	30/720	184084	
	75 50 90°	15/360	184087	
	75 75 90°	25/300	184088	
	110 50 90°	20/160	184096	
	110 75 90°	20/160	184097	
	110 110 90°	15/120	184099	
TREJGABALS ar garu rādiusu 90°	D _a (mm) D _a (mm) lenķis	gab.		
	75 75 90°	15/360	184089	
	110 75 90°	15/120	184098	
	110 110 90°	10/80	184101	
REVĪZIJA AR VĀKU	D(mm)	gab.		
	75	15/360	184464	
	110	18/144	184466	
	160	6/48	184468	
LĪKNIS	D _a (mm) lenķis	gab.		
	50	15°	32/1536	184303
		30°	32/1536	184323
		45°	25/1200	184333
		88°	25/1200	184363
	75	15°	30/720	184304
		30°	25/600	184324
		45°	25/600	184334
		88°	20/480	184364
	110	15°	30/240	184306
		30°	30/240	184326
		45°	30/240	184336
		88°	20/160	184366
	160	15°	10/80	184308
		30°	10/80	184328
		45°	8/64	184338
		88°	10/60	184368

STILLA[®] skaņu absorbējoša kanalizācijas cauruļu sistēma PP HT

NOSAUKUMS	IZMĒRS	IEPAK.	KODS
-----------	--------	--------	------

LĪKNIS ar garu rādiusu un divām uznavām



D _a (mm)	leņķis	gab.	
50	88°	30/720	184383
75	88°	15/360	184384
110	88°	15/120	184386
110*	88°	15/120	184376

* PP STILLA līkums ar garu rādiusu un vienu uznavu

LABOŠANAS DUBULTUZMAVA



D(mm)	gab.	
50	30/1440	184523
75	25/600	184524
110	20/240	184526
160	12/96	184528

DUBULTUZMAVA



D(mm)	gab.	
50	30/1440	184513
75	25/600	184514
110	20/240	184516
160	12/96	184518

ISĀ PĀREJA



D(mm)		D _a (mm)	gab.	
75	/	50	32/1536	184585
110	/	50	30/720	184589
110	/	75	20/480	184590
160*	/	110	16/192	184613

* PP STILLA garā pāreja - ekscentriskā

NOSLĒGTAPA



D(mm)	gab.	
50	120/5760	184473
75	35/1680	184474
110	30/720	184476
160	20/240	184478

SAIMNIECISKĀS KANALIZĀCIJAS SISTĒMA PVC

Nosaukums	Izmērs	Iepak.	Kods
-----------	--------	--------	------

CAURULE AR UZMAVU (COEX)

PVC, ieguldes klase SN4, EN 13476



D _g (mm)	s (mm)	L (m)	gab.	
110	3.0	0.5	50	010395
		1	50	010396
		2	50	010397
		3	50	010398
		6	50	010400
160	4.0	0.5	24	010402
		1	24	010401
		2	24	010403
		3	24	010404
		6	24	010405
200	4.9	0.5	15	010406
		1	15	010407
		2	15	010407
		3	15	010408
		6	15	010410
250	6.2	6	6	010412
315	7.7	6	6	010415
400	9.8	6	3	010425

CAURULE AR UZMAVU (COEX)

PVC, ieguldes klase SN8, EN 13476



D _g (mm)	s (mm)	L (m)	gab.	
110	3.2	2	50	010107
		3	50	010108
		6	50	010110
160	4.7	2	24	010117
		3	24	010118
		6	24	010120
200	5.9	2	15	010122
		3	15	010123
		6	15	010125
250	7.3	6	6	010130
315	9.2	6	6	010135
400	11.7	6	3	010141

CAURULE AR UZMAVU (COMPACT)

PVC, ieguldes klase SN8, EN 1401



D _g (mm)	s (mm)	L (m)	gab.	
110	3.2	6	50	010210
160	4.7	6	24	010220
200	5.9	6	15	010225
250	7.3	6	6	010230
315	9.2	6	6	010235
400	11.7	6	3	010241

SAIMNIECISKĀS KANALIZĀCIJAS SISTĒMA PVC

Nosaukums	Izmērs	Iepak.	Kods
-----------	--------	--------	------

DUBULTUZMAVA



D(mm)	gab.	
110	30/360	020722
160	15/115	020724
200	15/60	020725
250	1	020726
315	1	020727
400	1	020728

LĪKNIS



D _a (mm)	leņķis	gab.	
110	15°	30/360	020202
	30°	30/300	020212
	45°	30/270	020222
	67°		020233
	88°	25/200	020252
160	15°	20/110	020204
	30°	20/100	020214
	45°	20/90	020224
	67°		020234
	88°	20/70	020254
200	15°	10/50	020205
	30°	10/50	020215
	45°	10/45	020225
	67°		020235
	88°	10/35	020255
250	15°	1	020206
	30°	1	020216
	45°	1	020226
	88°	1	020256
315	15°	1	020207
	30°	1	020217
	45°	1	020227
	88°	1	020257
400	15°	1	020208
	30°	1	020218
	45°	1	020228
	88°	1	020258

TREJGABALS 45°



D _a (mm)	D _s (mm)	gab.	
110	110	10/100	020103
	110	3/51	020106
160	160	3/36	020108
	110	1/32	020109
200	160	1/24	020111
	200	1/20	020112
	110	1	020113
250	160	1	020115
	200	1	020116
	250	1	020117
	110	1	020118
315	160	1	020120
	200	1	020121
	250	1	020122
	315	1	020123
	110	1	020124
400	160	1	020126
	200	1	020127
	250	1	020128
	315	1	020129

* - pēc pasūtījuma

SAIMNIECISKĀS KANALIZĀCIJAS SISTĒMA PVC

Nosaukums	Izmērs	Iepak.	Kods
-----------	--------	--------	------

TREJGABALS 90°



D _g (mm)	D _a (mm)	gab.	
110	110	10/120	020150
160	110	3/48	020153
	160	3/45	020155
200	110	1/40	020156
	160	1/28	020158
	200	1/24	020159
250	160	1	020162
250	200	1	020163
250	250	1	020164
315	315	1	020170

LABOŠANAS DUBULTUZMAVA



D(mm)	gab.	
110	30/360	020702
160	15/115	020704
200	15/60	020705
250	1	020706
315	1	020707
400	1	020708

DIAMETRU PĀREJA



D _g (mm)	D _a (mm)	gab.	
160	/ 110	15/250	020905
200	/ 160	10/115	020911
250	/ 200	1	020913
315	/ 200	1	020914
315	/ 250	1	020915
400	/ 315	1	020916

UZMAVAS NOSLĒGTAPA



D(mm)	gab.	
110	28/1344	020502
160	20/420	020504
200	10	020505
250	1	020506
315	1	020507
400	1	020508

REVĪZIJA AR VĀKU



D(mm)	gab.	
110	10	020402
160	5	020404
200	5	020405
250	*	020406

VIENVIRZIENA VĀRSTS

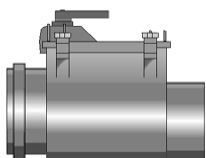

D(mm)	gab.	
110	1	023005
160	1	023010
200	1	023015
250	1	023020
315	1	023025
400	1	023030

* - pēc pasūtījuma

SAIMNIECISKĀS KANALIZĀCIJAS SISTĒMA PVC

Nosaukums	Izmērs	Iepak.	Kods
-----------	--------	--------	------

AIZSARGUZMAVA



D(mm)	gab.	
110	1	021401
160	1	021404
200	1	021405
250	*	021406
315	*	021407
400	*	021408

PĀREJA NO UZMAVAS UZ ĶETA CAURULI



D _g (mm)		D _ķ (mm)	gab.	
110	/	126	1	021002
160	/	180	1	021004
200	/	265	1	021005

PĀREJA NO UZMAVAS UZ BETONA VAI KERAMIKAS CAURULI (TERMOUZMAVA)



D _g (mm)		D _ķ (mm)	gab.	
110	/	160	1	021301
160	/	224	1	021303
200	/	300	1	021304
250	/	354	1	021305
315	/	416	1	021306
400	/	560	1	021307

PĀREJA NO CAURULES UZ BETONA VAI KERAMIKAS CAURULES UZMAVU

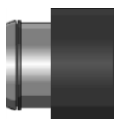

D _g (mm)		D _ķ (mm)	gab.	
110	/	148	1	021201
160	/	206	1	021203
200	/	264	1	021204
250	/	329	1	021205

* - pēc pasūtījuma

SAIMNIECISKĀS KANALIZĀCIJAS SISTĒMA PRAGMA®

Nosaukums	Izmērs	Iepak.	Kods
-----------	--------	--------	------

PRAGMA®
CAURULE AR UZMAVU
ieguldes klase SN8



D _a (mm)	d _i (mm)	gab.	
160	/ 139	28	010724
200	/ 174	20	010725
250	/ 218	8	010730
315	/ 276	6	010735
400	/ 348	3	010741
500	/ 435	2	010750
630	/ 548	2	010763

caurules garums - 6m, krāsa - sarkanbrūna
iekšpuse gluda, ārpusē rievota, blīvgumija pēdējā rievā

PRAGMA®
LĪKNIS

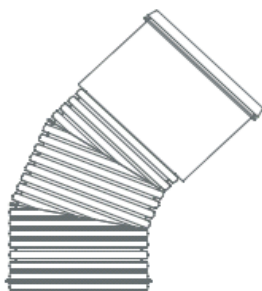

D _a (mm)		gab.	
160	/ 15°	12	027204
	/ 30°	8	027214
	/ 45°	8	027224
200	/ 15°	6	027205
	/ 30°	5	027215
	/ 45°	4	027225
250	/ 15°	1	027206
	/ 30°	1	027216
	/ 45°	1	027226
315	/ 15°	1	027207
	/ 30°	1	027217
	/ 45°	1	027227
400	/ 15°	1	027208
	/ 30°	1	027218
	/ 45°	1	027228
	/ 87°	1	027258
500	/ 15°	1	027268
	/ 30°	1	027269
	/ 45°	1	027270
	/ 87°	1	027271
630	/ 15°	1	027276
	/ 30°	1	027277
	/ 45°	1	027278
	/ 87°	1	027279

PRAGMA®
DUBULTUZMAVA



D _a (mm)	gab.	
110	10	145010
160	10	027724
200	8	027725
250	1	027726
315	1	027727
400	1	027728
500	1	027729
630	1	027730

* - pēc pasūtījuma

SAIMNIECISKĀS KANALIZĀCIJAS SISTĒMA PRAGMA®

Nosaukums	Izmērs	Iepak.	Kods
-----------	--------	--------	------

**PRAGMA®
BLĪVGUMIJA**



D _a (mm)	gab.	
110	1	145210
160	1	145220
200	1	145230
250	1	145240
315	1	145250
400	1	145260
500	1	145270
630	1	145280

**PRAGMA®
UZMAVAS NOSLĒGTAPA**

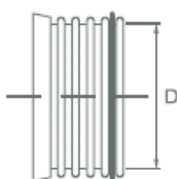

D _a (mm)	gab.	
160	10	027504
200	8	027505
250	1	027506
315	1	027507
400	1	027508
500	1	027509
630	1	027510

**UZMAVAS BLĪVGUMIJA +
FIKSĒŠANAS GREDZENS**



D _a (mm)	gab.	
110	10	145110
160	10	145120
200	8	145130
250	1	145140
315	1	145150
400	1	145160
500	1	145170

**PĀREJA DUBULTSIENU
CAURULE - PVC UZMAVA**

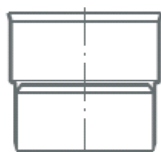

D _a (mm)	gab.	
110	10	145310
160	10	145320
200	8	145330
250	1	145340
315	1	145350
400	1	145360
500	1	145370

**PRAGMA®
AIZSARGUZMAVA /
LABOŠANAS DUBULTUZMAVA**



D _a (mm)	gab.	
160	10	027704
200	8	027705
250	1	027706
315	1	027707
400	1	027708
500	1	027709
630	1	027710

SAIMNIECISKĀS KANALIZĀCIJAS SISTĒMA PRAGMA®

Nosaukums	Izmērs	Iepak.	Kods
-----------	--------	--------	------

**PRAGMA®
TREJGABALS 45°**

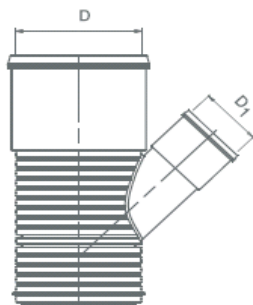

	D_a (mm)	gab.	
160	/ 110	5	027106
	/ 160	4	027108
200	/ 110	30	027109
	/ 160	24	027111
	/ 200	20	027112
250	/ 110	1	027113
	/ 160	1	027115
	/ 200	1	027116
315	/ 110	1	027118
	/ 160	1	027120
	/ 200	1	027121
	/ 250	1	027122
	/ 110	1	027124
	/ 160	1	027126
400	/ 200	1	027127
	/ 250	1	027128
	/ 315	1	027129
500	/ 110	1	027160
	/ 160	1	027162
	/ 200	1	027164
	/ 250	1	027166
	/ 315	1	027168
630	/ 400	1	027170
	/ 110	1	027172
	/ 160	1	027174
	/ 200	1	027176
	/ 250	1	027178
	/ 315	1	027180
	/ 400	1	027182
	/ 500	1	027184

**PRAGMA®
DIAMETRU PĀREJA**



	D_a (mm)	gab.	
160	/ 110	10	027905
200	/ 110	8	027908
200	/ 160	1	027911
250	/ 200	1	027913
315	/ 200	1	027914
315	/ 250	1	027915
400	/ 315	1	027917
500	/ 315	1	027926
500	/ 400	1	027927
630	/ 500	1	027937

SAIMNIECISKĀS KANALIZĀCIJAS SISTĒMA PRAGMA®

Nosaukums	Izmērs	Iepak.	Kods
-----------	--------	--------	------

PRAGMA® ID
CAURULE AR UZMAVU
ieguldes klase T8

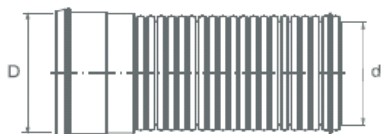

D _a (mm)	d _i (mm)	gab.	
228	/ 200	6	010825
285	/ 250	6	010830
343	/ 300	6	010835
458	/ 400	3	010840
573	/ 500	2	010850
688	/ 600	2	010860
925	/ 800	2	010880
1140	/ 1000	1	010890

caurules garums - 6m, krāsa - sarkanbrūna
iekšpuse gluda, ārpuse rievota, blīvgumija pēdējā rievā

PRAGMA® ID
DUBULTUZMAVA



D _a (mm)	gab.	
343	1	028727
458	1	028728
573	1	028729
688	1	028730
919	1	028731

PRAGMA® ID
AIZSARGUZMAVA /
LABOŠANAS DUBULTUZMAVA



D _a (mm)	gab.	
225	1	028705
285	1	028706
343	1	028707
458	1	028708
573	1	028709
688	1	028710
919	1	028711

PRAGMA® ID
BLĪVGUMIJA



D _a (mm)	gab.	
343	1	145258
458	1	145268
573	1	145278
688	1	145288
919	1	145298

PĀREJA DUBULTSIENU
CAURULE - PVC UZMAVA

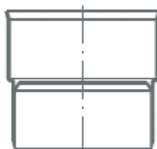

D _a (mm)	gab.		
225	/ 200	1	145338
285	/ 250	1	145348
343	/ 315	1	145358
458	/ 400	1	145368

* - pēc pasūtījuma

SAIMNIECISKĀS KANALIZĀCIJAS SISTĒMA PRAGMA®

Nosaukums	Izmērs	Iepak.	Kods
-----------	--------	--------	------

**PRAGMA® ID
LĪKNIS**

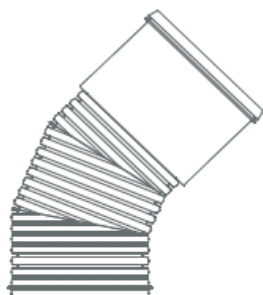

	D _a (mm)		gab.	Kods
	/	°		
343	/	15°	1	028207
	/	30°	1	028217
	/	45°	1	028227
	/	90°	1	028257
458	/	15°	1	028208
	/	30°	1	028218
	/	45°	1	028228
	/	90°	1	028258
573	/	15°	1	028268
	/	30°	1	028269
	/	45°	1	028270
	/	90°	1	028271
688	/	15°	1	028272
	/	30°	1	028273
	/	45°	1	028274
	/	90°	1	028275
919	/	15°	1	028276
	/	30°	1	028277
	/	45°	1	028278
	/	90°	1	028279

**PRAGMA® ID
TREJGABALS 45°**

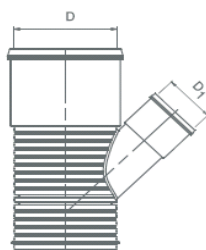

	D _a (mm)		gab.	Kods
	/	D _a (mm)		
225	/	225	1	028112
285	/	225	1	027116
343	/	160	1	028120
	/	200	1	028121
458	/	160	1	028126
	/	200	1	028127
	/	250	1	028128
	/	343	1	028129
	/	343	1	028129
573	/	160	1	028162
	/	200	1	028164
	/	343	1	028168
688	/	458	1	028170
	/	160	1	028174
	/	200	1	028176
	/	250	1	028178
	/	343	1	028180
	/	458	1	028182
	/	573	1	028184

**PRAGMA ID®
UZMAVAS NOSLĒGTAPA**

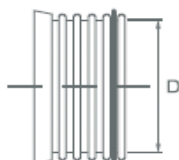

	D _a (mm)		Kods
		gab.	
225		1	027505
285		1	027506
343		1	028507
458		1	028508
573		1	028509
688		1	028510
919			

STARK[®] DW

Nosaukums	Izmērs	Iepak.	Kods
-----------	--------	--------	------

STARK[®] DW
CAURULE AR UZMAVU
 ieguldes klase SN8



D _a (mm)	d _i (mm)	gab.	
110	/ 139	300	130110
160	/ 139	168	130160
200	/ 174	120	130200
250	/ 218	48	130250
315	/ 276	36	130315
400	/ 348	18	130400
500	/ 435	12	130500
630	/ 548	12	130630

caurules garums - 6m, krāsa - melna
 iekšpuse gluda, ārpuse rievota, blīvgumija pēdējā rievā

PRAGMA[®]
LĪKNIS

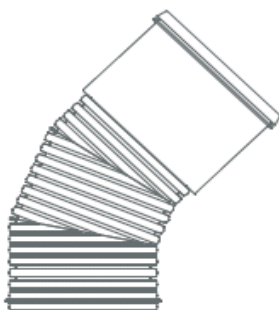

D _a (mm)		gab.	
160	/ 15°	12	027204
	/ 30°	8	027214
	/ 45°	8	027224
200	/ 15°	6	027205
	/ 30°	5	027215
	/ 45°	4	027225
250	/ 15°	1	027206
	/ 30°	1	027216
	/ 45°	1	027226
315	/ 15°	1	027207
	/ 30°	1	027217
	/ 45°	1	027227
400	/ 15°	1	027208
	/ 30°	1	027218
	/ 45°	1	027228
	/ 87°	1	027258
500	/ 15°	1	027268
	/ 30°	1	027269
	/ 45°	1	027270
	/ 87°	1	027271
630	/ 15°	1	027276
	/ 30°	1	027277
	/ 45°	1	027278
	/ 87°	1	027279

PRAGMA[®]
DUBULTUZMAVA



D _a (mm)	gab.	
110	10	145010
160	10	027724
200	8	027725
250	1	027726
315	1	027727
400	1	027728
500	1	027729
630	1	027730

PRAGMA[®]
BLĪVGUMIJA

D _a (mm)	gab.	
110	1	145210
160	1	145220

* - pēc pasūtījuma

STARK® DW

Nosaukums	Izmērs	Iepak.	Kods
	200	1	145230
	250	1	145240
	315	1	145250
	400	1	145260
	500	1	145270
	630	1	145280

PRAGMA®
UZMAVAS NOSLĒGTAPA

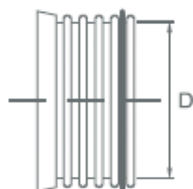

D _a (mm)	gab.	
160	10	027504
200	8	027505
250	1	027506
315	1	027507
400	1	027508
500	1	027509
630	1	027510

UZMAVAS BLĪVGUMIJA +
FIKSĒŠANAS GREDZENS



D _a (mm)	gab.	
110	10	145110
160	10	145120
200	8	145130
250	1	145140
315	1	145150
400	1	145160
500	1	145170

PĀREJA DUBULTSIENU
CAURULE - PVC UZMAVA

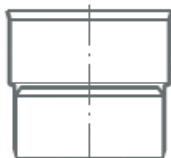

D _a (mm)	gab.	
110	10	145310
160	10	145320
200	8	145330
250	1	145340
315	1	145350
400	1	145360
500	1	145370

PRAGMA®
AIZSARGUZMAVA /
LABOŠANAS DUBULTUZMAVA



D _a (mm)	gab.	
160	10	027704
200	8	027705
250	1	027706
315	1	027707
400	1	027708
500	1	027709
630	1	027710

PRAGMA®
TREJGABALS 45°

D _a (mm)	gab.		
160	/ 110	5	027106
	/ 160	4	027108
200	/ 110	30	027109
	/ 160	24	027111
	/ 200	20	027112
250	/ 110	1	027113
	/ 160	1	027115
	/ 200	1	027116
	/ 110	1	027118

* - pēc pasūtījuma

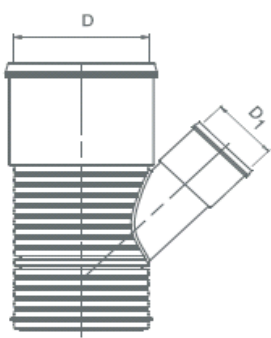
Nosaukums	Izmērs	Iepak.	Kods	
	315	/ 160	1	027120
		/ 200	1	027121
		/ 250	1	027122
	400	/ 110	1	027124
		/ 160	1	027126
		/ 200	1	027127
		/ 250	1	027128
		/ 315	1	027129
	500	/ 110	1	027160
		/ 160	1	027162
		/ 200	1	027164
		/ 250	1	027166
/ 315		1	027168	
/ 400		1	027170	
630	/ 110	1	027172	
	/ 160	1	027174	
	/ 200	1	027176	
	/ 250	1	027178	
	/ 315	1	027180	
	/ 400	1	027182	
	/ 500	1	027184	

PRAGMA®
DIAMETRU PĀREJA



D _a (mm)		gab.	
160	/ 110	10	027905
200	/ 110	8	027908
200	/ 160	1	027911
250	/ 200	1	027913
315	/ 200	1	027914
315	/ 250	1	027915
400	/ 315	1	027917
500	/ 315	1	027926
500	/ 400	1	027927
630	/ 500	1	027937

PRAGMA® ID
CAURULE AR UZMAVU
ieguldes klase T8



D _a (mm)	d _i (mm)	gab.	
228	/ 200	6	010825
285	/ 250	6	010830
343	/ 300	6	010835
458	/ 400	3	010840
573	/ 500	2	010850
688	/ 600	2	010860
925	/ 800	2	010880
1140	/ 1000	1	010890

caurules garums - 6m, krāsa - sarkanbrūna
iekšpuse gluda, ārpuse rievota, blīvumija pēdējā rievā

PRAGMA® ID
DUBULTUZMAVA



D _a (mm)	gab.	
343	1	028727
458	1	028728
573	1	028729
688	1	028730
919	1	028731

* - pēc pasūtījuma

Nosaukums	Izmērs	Iepak.	Kods
-----------	--------	--------	------

**PRAGMA® ID
AIZSARGUZMAVA /
LABOŠANAS DUBULTUZMAVA**



D _a (mm)	gab.	
225	1	028705
285	1	028706
343	1	028707
458	1	028708
573	1	028709
688	1	028710
919	1	028711

**PRAGMA® ID
BLĪVGUMIJA**



D _a (mm)	gab.	
343	1	145258
458	1	145268
573	1	145278
688	1	145288
919	1	145298

**PĀREJA DUBULTSIENU
CAURULE - PVC UZMAVA**

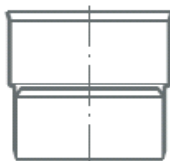

D _a (mm)	gab.	
225 / 200	1	145338
285 / 250	1	145348
343 / 315	1	145358
458 / 400	1	145368

**PRAGMA® ID
LĪKNIS**

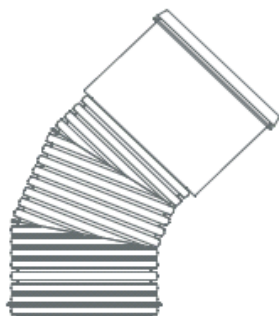

D _a (mm)		gab.	
343	/ 15°	1	028207
	/ 30°	1	028217
	/ 45°	1	028227
	/ 90°	1	028257
458	/ 15°	1	028208
	/ 30°	1	028218
	/ 45°	1	028228
	/ 90°	1	028258
573	/ 15°	1	028268
	/ 30°	1	028269
	/ 45°	1	028270
	/ 90°	1	028271
688	/ 15°	1	028272
	/ 30°	1	028273
	/ 45°	1	028274
	/ 90°	1	028275
919	/ 15°		028276
	/ 30°		028277
	/ 45°		028278
	/ 90°		028279

**PRAGMA® ID
TREJGABALS 45°**

D _a (mm)		gab.	
225 / 225		1	028112
285 / 225		1	027116
343 / 160		1	028120

* - pēc pasūtījuma

STARK® DW

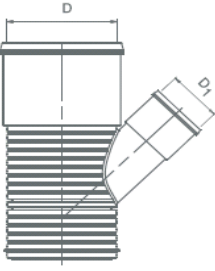
Nosaukums	Izmērs	Iepak.	Kods
	548 / 200	1	028121
	458 / 160	1	028126
	458 / 200	1	028127
	458 / 250	1	028128
	458 / 343	1	028129
	573 / 160	1	028162
	573 / 200	1	028164
	573 / 343	1	028168
	573 / 458	1	028170
	688 / 160	1	028174
	688 / 200	1	028176
	688 / 250	1	028178
	688 / 343	1	028180
	688 / 458	1	028182
	688 / 573	1	028184

PRAGMA ID® UZMAVAS NOSLĒGTAPA

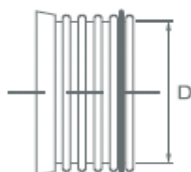

D _g (mm)	gab.	
225	1	027505
285	1	027506
343	1	028507
458	1	028508
573	1	028509
688	1	028510
919		

KANALIZĀCIJAS SKATAKAS

	Izmērs	Iepak.	Kods	
--	--------	--------	------	--

POLAR BSB SKATAKAS PAMATNE

pamatne ar 3 ieejošajiem un 1 izejošo
pievienojumu PRAGMA caurulēm

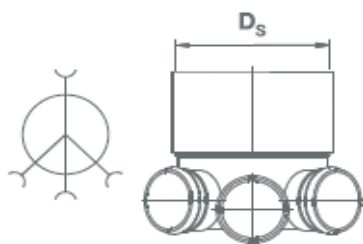

D _n (mm)	D _s (mm)	gab.		
110	/ 400	12	080960	
160	/ 400	12	087952	
200	/ 400	12	087953	
250	/ 400	12	088964	

POLAR ST SKATAKAS PAMATNE

pamatne ar 1 ieejošo un 1 izejošo
pievienojumu PRAGMA caurulēm

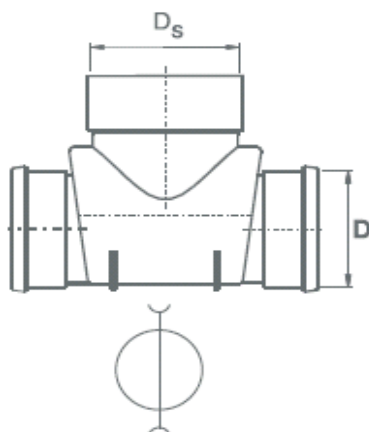

D _n (mm)	D _s (mm)	gab.		
160	/ 400	12	088882	
200	/ 400	12	088883	
250	/ 400	3	087855	
315	/ 400	3	087860	
400	/ 400	3	087865	
500	/ 400	1	087870	
630	/ 400	1	087875	

REVĪZIJAS SKATAKAS PAMATNE

pamatne ar 1 ieejošo un 1 izejošo
pievienojumu PVC caurulēm

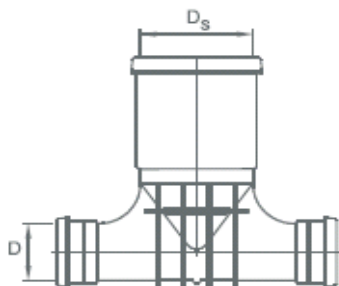

D _n (mm)	D _s (mm)	gab.		
110	/ 200	1	021600	
160	/ 200	1	021601	
200	/ 200	1	021602	

BLĪVGUMIJA (augstuma regulēšanas caurulei)



D _n (mm)	D _s (mm)	gab.		
400		1	145260	
630		1	145280	

MANŽETE (teleskopiskajai caurulei)



D _n (mm)	gab.		
160 / 200 PVC	1	081500	
315 / 400 PVC	1	081501	
315 / 400 DW	1	081504	
500 / 630 DW	1	081505	

KANALIZĀCIJAS SKATAKAS

	Izmērs	Iepak.	Kods	
--	--------	--------	------	--



ĶETA RĀMIS AR SLĒGTU VĀKU

D_i (mm)	D_a (mm)	gab.		
160	320	1	086523	
315	490	1	083318	
500	650	1	086503	
630	820	1	086507	

TELESKOPIKĀS CAURULES (viensienas)



D_i (mm)	L (m)		
160	6	010405	
315	6	082101	
500	6	082103	
630	6	082106	

AUGSTUMA REGULĒŠANAS CAURULES (dubultsienu)

D_i (mm)	L (m)		
400	6	131400	
630	6	131630	

AUGSTUMA REGULĒŠANAS CAURULES (gludsienu)

D_i (mm)	L (m)		
200	6	010410	
400	6	010425	

PAPILDUS METINĀTS PIEVIENOJUMS

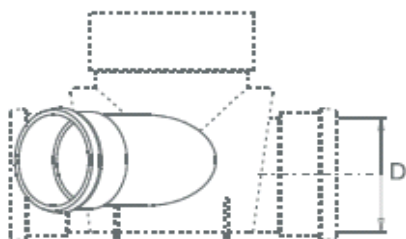

D_i (mm)			
50		MET50	
110		MET110	
160		MET160	
200		MET200	
250		MET250	
315		MET315	
400		MET400	
500		MET500	
630		MET630	

LIETUS ŪDENS NOSĒDAKAS

	Izmērs	Iepak.	Kods	
--	--------	--------	------	--



ĶETA RĀMIS (APAĻŠ) AR RESTI 40t

D_i(mm) D_a(mm)

315	/	490		083318k	
500	/	650		086506	

JAUNUMS!

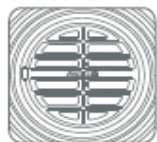

ĶETA RĀMIS AR RESTI (KVADRĀTS AR EŅĢĒM) 40t

D_i(mm) D_a(mm)

315	/	410		083402	
-----	---	-----	--	--------	--

*cenas pēc pieprasījuma

MANŽETE (teleskopiskajai caurulei)

D_n(mm)



315	/	400 DW		081504	
315	/	400 PVC		081501	
500	/	630 DW		081505	

TELESKOPISKĀ CAURULE (viensienas)

D_i(mm)

L (m)



315		6	082101	
500		6	082103	

AUGSTUMA REGULĒŠANAS CAURULE (dubultsienu)

D_i(mm)

L (m)



400		6	131400	
630		6	131630	



ĶETA RĀMIS AR KUPOLU 10t un teleskopisko cauruli 0,4m

D_i(mm)

315			082905	
-----	--	--	--------	--

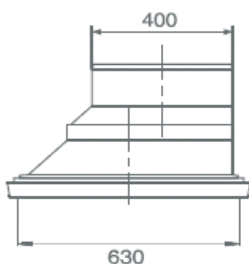

NOSĒDAKAS REDUKCIJA

D_i(mm)

630	/	400		132241	
-----	---	-----	--	--------	--

LIETUS ŪDENS NOSĒDAKAS

	Izmērs	Iepak.	Kods	
--	--------	--------	------	--

NOSĒDAKAS VĀKS (augšai)

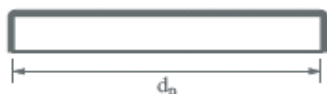

D_i(mm)

400		081582	
630		081599	

NOSĒDAKAS PP PAMATNE (apakšai)



D_i(mm)

400		132154	
630		081598	

LIETUS ŪDENS PIEVIENOŠANĀS BLĪVGUMIJA



D_a(mm)

110		081450	
160		081452	
200		081454	
250		081508	
315		081509	

PĀREJA DUBULTSIENU CAURULE - PVC UZMAVA

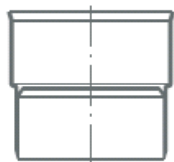

D_a(mm)

110		145310	
160		145320	
200		145330	
250		145340	
315		145350	

SIFONS PVC



D_a(mm)

110		085011	
160		085016	
200		085020	

LIETUS ŪDEŅU SAVĀCĒJS

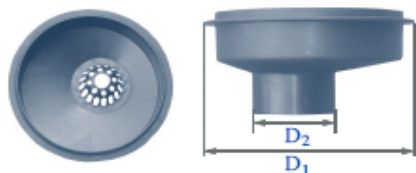

D_i(mm) D_a(mm)

315	/	110		140155	
-----	---	-----	--	--------	--

DRENĀŽAS SISTĒMA

Nosaukums	Izmērs	Iepak.	Kods
-----------	--------	--------	------

PP DUBULTSIENU CAURULE AR UZMAVU PERFORĀCIJA 180°, ieguldes klase T8

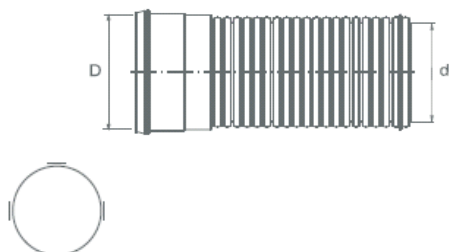

D _a (mm)	d _i (mm)	gab.		
110	/	100	57	247564
160	/	140	28	247569
200	/	174	15	220200
250	/	218	15	220250
315	/	274	8	220230
343	/	300	8	220442
458	/	400	6	220444
573	/	500	6	220446

krāsa - melna; iekšpuse gluda, ārpuse rievota, cauruļu garums

PP DUBULTSIENU CAURULE AR UZMAVU PERFORĀCIJA 360°, ieguldes klase T8

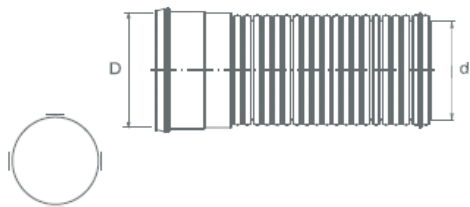

D _a (mm)	d _i (mm)	gab.		
110	/	100	57	247563
160	/	139	28	247568
200	/	174	15	220380
315	/	274	8	220330
350	/	300		450420
465	/	400		450430
580	/	500		450440

krāsa - melna; iekšpuse gluda, ārpuse rievota, cauruļu garums veidgabali jāņem no 4. nodaļas

PVC DRENĀŽAS CAURULE

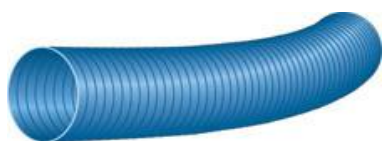

D _a (mm)	d _i (mm)	m		
58	/	50	50	240010
58	/	50	250	243105
74	/	65	50	243110
92	/	80	50	243220
128	/	113	50	243310
128	/	113	75	243315
160	/	145	50	243525

PVC DRENĀŽAS CAURULE ar kokosa filtru



D _a (mm)	d _i (mm)	m		
58	/	50	50	340030
58	/	50	150	340040
92	/	80	25	340215
92	/	80	75	340240
128	/	113	50	340320
160	/	145	25	340410

DRENĀŽAS SISTĒMA

Nosaukums	Izmērs	Iepak.	Kods
-----------	--------	--------	------

DUBULTUZMAVA



d _n (mm)	gab.	
58	46 / 1104	254110
74	30 / 720	254210
92	36 / 432	254310
128	18 / 216	254410
160	12 / 144	254415

TREJGABALS



d _n (mm)	gab.	
58 / 58	30 / 720	250110
92 / 92	18 / 216	250330
128 / 92	12 / 96	250430
128 / 128	10 / 60	250440
160 / 160	10 / 40	250445
160 / 128	10 / 60	250455

LĪKUMS 90°

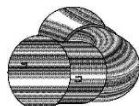

d _n (mm)	gab.	
92	25 / 300	259080
128	6 / 72	259090

NOSLĒGTAPA



d _n (mm)	gab.	
58	50	257110
74	50	257210
92	50	257310
128	25	257410
160	20	257415

REDUKCIJA



d _n (mm)	gab.	
92 / 58	18 / 432	255310
128 / 92	20 / 240	255410
160 / 128	6 / 96	255415

PĀREJA UZ GLUDSIENU CAURULES UZMAVU



d _n (mm)	gab.	
92 / 110	18 / 432	278220
128 / 110	12 / 288	278230

3 6m

3 6m

Lietus ūdens novadīšanas sistēma - **STORMBOX**

Nosaukums	Izmērs	Iepak.	Kods
-----------	--------	--------	------

STORMBOX



Garums (mm) Augstums (mm) Platums (mm) gab.

1200	300	600	1	390500
------	-----	-----	---	--------

Ietilpība - 206 litri, svars - 8 kg.

STORMBOX pamatne

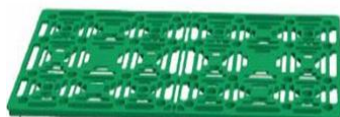

Garums (mm) Augstums (mm) Platums (mm) gab.

1200	-	600	1	390501
------	---	-----	---	--------

Svars - 1.7 kg.

STORMBOX klipis



Garums (mm) Augstums (mm) Platums (mm) gab.

-	-	-	18	390502
---	---	---	----	--------

Svars - 0.01 kg

Piezīmes:

- Pamatne ir vajadzīga tikai apakšējām kasetēm.
- Savienojot kasetes pamatne nav nepieciešama.
- Vienai kasetei ir nepieciešami 12. klipši

Aprēķinu tabula

Ievadīt datus	
kopējais kasešu skaits (augstums)	1
kopējais kasešu skaits (platums)	1
kopējais kasešu skaits (garums)	1
Aprēķinu rezultāti	
kopējais kasešu skaits	1
kopējais tilpums (m ³)	0
kopējais pamatņu skaits	1
kopējais klipšu skaits	12
vidējais klipšu skaits uz vienu kaseti	12.0
Nemainīgās vērtības	
kopējais klipšu skaits īsākai malai	2
kopējais klipšu skaits garākai malai	4
kopējais klipšu skaits vienai kasetei	12

augstums

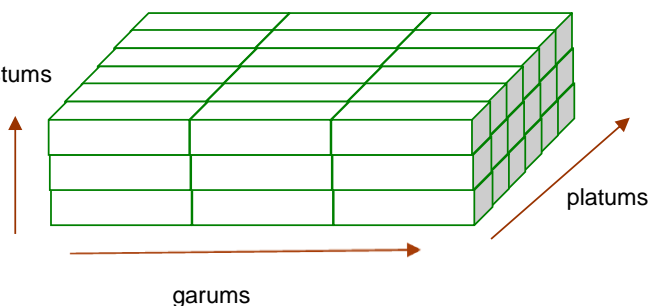

garums

platums

SPIEDVADU SISTĒMA PE

Nosaukums	Izmērs	Iepak.	Kods
-----------	--------	--------	------

spiediena klase PN16

PE-100 CAURULE, melna ar zilu svītru
SDR 11, standarts: EN 12201



D _a (mm)	s (mm)	L (m)	m	
20	2.0	100	1100	1802001
		200	2200	1802002
25	2.3	100	1100	1802501
		200	1400	1802502
		500	1500	1802505
32	3.0	100	700	1803201
		200	1200	1803202
		500	1500	1803205
40	3.7	100	600	1804001
		200	800	1804002
		500	1500	1804005
50	4.6	100	400	1805001
		200	600	1805002
63	5.8	100	100	1806301

spiediena klase PN10

PE-100 CAURULE
PE-100 CAURULE, melna ar zilu svītru
SDR 17, standarts: EN 12201

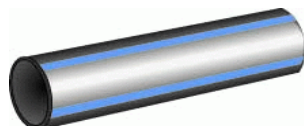

D _a (mm)	s (mm)	L (m)	m	
40	2.4	200	800	639319
		300	1200	639419
		400	1600	694194
		500	1500	639619
63	3.8	6	456	714094
		12	456	714024
		100	100	714025
75	4.5	6	396	714095
		12	396	714026
		100	100	714027
90	5.4	6	336	714095
		12	336	714031
		100	100	714032
110	6.6	6	174	715034
		12	348	714034
		50	50	714035
		100	100	714036
125	7.4	12	312	714037
140	8.3	12	276	714040
160	9.5	6	120	715043
160	9.5	12	240	714043
180	10.7	12	168	714046
200	11.9	6	36	715049
200	11.9	12	72	714049
225	13.4	12	60	714052
250	14.8	12	48	714055
280	16.6	12	48	714058
315	18.7	12	36	714061
355	21.1	12	36	714064
400	23.7	12	36	714067
450	26.7	12		714070
500	29.7	12		714073
560	32.2	12		714076
630	37.4	12		714079
710	42.1	12		714082

SPIEDVADU SISTĒMA PE

Nosaukums	Izmērs	Iepak.	Kods
-----------	--------	--------	------

Spiediena klase PN6 un PN16 pēc pieprasījuma

PP KOMPRESIJAS VEIDGABALI PE CAURULĒM

Nosaukums	Izmērs	Iepak.	Kods
-----------	--------	--------	------

DUBULTUZMAVA
 PN 16 Ø 20 - 63
 PN 10 Ø 75 - 110



D(mm)	gab.	
20 x 20	25 / 175	701.020
25 x 25	25 / 125	701.025
32 x 32	25 / 75	701.032
40 x 40	45	701.040
50 x 50	35	701.050
63 x 63	20	701.063
75 x 75	12	701.075
90 x 90	5	701.090
110 x 110	3	701.110

REDUKCIJAS
DUBULTUZMAVA
 PN 16 Ø 20 - 63
 PN 10 Ø 75 - 110



D(mm)	gab.	
25x20	25 / 150	702.025
32x25	25 / 75	702.032
40x32	60	702.040
50x40	40	702.050
63x50	25	702.063
75x63	12	702.075
90x75	6	702.090
110x90	4	702.110

PĀREJA UZ IEKŠĒJO
VĪTNI
 PN 16 Ø 20 - 63
 PN 10 Ø 75 - 110



D(mm)	gab.	
20x $\frac{1}{2}$ "	25 / 350	703.020
20x $\frac{3}{4}$ "	25 / 300	703.022
25x $1\frac{1}{2}$ "	25 / 225	703.024
25x $\frac{3}{4}$ "	25 / 200	703.025
25x1"	25 / 150	703.027
32x $\frac{3}{4}$ "	25 / 150	703.031
32x1"	25 / 150	703.032
32x $1\frac{1}{4}$ "	25 / 150	703.033
40x1"	100	703.039
40x $1\frac{1}{4}$ "	100	703.040
50x $1\frac{1}{2}$ "	18	703.050
50x $1\frac{1}{4}$ "	18	703.051
63x2"	35	703.063
75x $2\frac{1}{2}$ "	18	703.075
90x3"	10	703.090
110x4"	6	703.110

PP KOMPRESIJAS VEIDGABALI PE CAURULĒM

Nosaukums	Izmērs	Iepak.	Kods
-----------	--------	--------	------

DUBULTUZMAVU LĪKNIS

PN 16 Ø 20 - 63

PN 10 Ø 75 - 110



D(mm)	gab.	
20	25 / 150	706.020
25	25 / 125	706.025
32	25 / 75	706.032
40	45	706.040
50	30	706.050
63	15	706.063
75	8	706.075
90	4	706.090
110	2	706.110

PĀREJA UZ ĀRĒJO

VĪTNI

PN 16 Ø 20 - 63

PN 10 Ø 75 - 110



D(mm)	gab.	
20x1/2"	25 / 400	704.020
20x3/4"	25 / 375	704.021
25x1/2"	25 / 250	704.024
25x3/4"	25 / 225	704.025
25x1"	25 / 200	704.026
32x3/4"	25 / 150	704.031
32x1"	25 / 150	704.032
32x1 1/4"	25 / 150	704.033
40x1"	100	704.039
40x1 1/4"	100	704.040
40x1 1/2"	100	704.041
50x1 1/2"	75	704.050
50x2"	70	704.051
63x2"	35	704.063
75x2"	20	704.074
75x2 1/2"	20	704.075
90x3"	10	704.090
110x4"	7	704.110

NOSLĒGTAPA

PN 16 Ø 20 - 63

PN 10 Ø 75 - 110



D(mm)	gab.	
20	25 / 400	705.020
25	25 / 250	705.025
32	25 / 150	705.032
40	110	705.040
50	75	705.050
63	40	705.063
75	22	705.075
90	10	705.090
110	7	705.110

PP KOMPRESIJAS VEIDGABALI PE CAURULĒM

Nosaukums	Izmērs	Iepak.	Kods
-----------	--------	--------	------

TREJGABALS AR IEKŠĒJĀS VĪTNES ATZARU

PN 16 Ø 20 - 63
PN 10 Ø 75 - 110



D(mm)	gab.	
20x $\frac{1}{2}$ "x20	25 / 125	710.020
25x $\frac{1}{2}$ "x25	25 / 75	710.024
25x $\frac{3}{4}$ "x25	25 / 75	710.025
32x $\frac{3}{4}$ "x32	15 / 45	710.031
32x1"x32	15 / 45	710.032
40x1 $\frac{1}{4}$ "x40	35	710.040
50x1 $\frac{1}{2}$ "x50	25	710.050
63x2"x63	15	710.063

LĪKNIS AR PĀREJU UZ ĀRĒJO VĪTNI

PN 16 Ø 20 - 63



D(mm)	gab.	
20x $\frac{1}{2}$ "	25 / 150	707.020
25x $\frac{1}{2}$ "	25 / 100	707.024
25x $\frac{3}{4}$ "	25 / 100	707.025
32x1"	15 / 60	707.032
40x1 $\frac{1}{4}$ "	35	707.040
50x1 $\frac{1}{2}$ "	25	707.050
63x2"	16	707.063

LĪKNIS AR PĀREJU UZ IEKŠĒJO VĪTNI

PN 16 Ø 20 - 63
PN 10 Ø 75 - 110



D(mm)	gab.	
20x $\frac{1}{2}$ "	25 / 250	708.020
25x $\frac{3}{4}$ "	25 / 150	708.025
32x $\frac{3}{4}$ "	25 / 100	708.031
32x1"	25 / 100	708.032
40x1 $\frac{1}{4}$ "	70	708.040
50x1 $\frac{1}{2}$ "	50	708.050
63x2"	25	708.063

TREJGABALS PN 16 Ø 20 - 63 PN 10 Ø 75 - 110



D(mm)	gab.	
20x20x20	25 / 100	709.020
25x25x25	25 / 75	709.025
32x32x32	15 / 45	709.032
40x40x40	30	709.040
50x50x50	20	709.050
63x63x63	11	709.063
75x75x75	5	709.075
90x90x90	2	709.090
110x110x110	1	709.110

PP KOMPRESIJAS VEIDGABALI PE CAURULĒM

Nosaukums	Izmērs	Iepak.	Kods
-----------	--------	--------	------

REDUKCIJAS TREJGABALS

PN 16 Ø 20 - 63
PN 10 Ø 75 - 110



D(mm)	gab.	
25x20x25	25 / 50	713.025
32x25x32	15 / 45	713.032
40x32x40	20	713.040
50x40x50	12	713.050
63x50x63	8	713.063

TREJGABALS AR ĀRĒJĀS VĪTNES ATZARU

PN 16 Ø 20 - 63
PN 10 Ø 75 - 110



D(mm)	gab.	
20x $\frac{1}{2}$ "x20	25 / 150	711.020
25x $\frac{3}{4}$ "x25	25 / 100	711.025
32x1"x32	15 / 60	711.032
40x1 $\frac{1}{4}$ "x40	35	711.040
63x2"x63	16	711.063

PĀREJA UZ FLANCI

PN 16 Ø 20 - 63
PN 10 Ø 75 - 110



D(mm)	gab.	
50x50	16	714.050
63x50	12	714.063
63x65	12	714.064
75x65	8	714.075
75x80	6	714.076
90x80	5	714.090
90x100	5	714.091
110x100	4	714.110

SEDLI AR IEKŠĒJĀS VĪTNES PIEVIENOJUMU



D(mm)	gab.	
25x $\frac{3}{4}$ "	1	810101
32x $\frac{3}{4}$ "	1	810102
40x1"	1	810104
50x1"	1	810105
63x1"	1	810106
63x1 $\frac{1}{2}$ "	1	810126
75x1"	1	810108
75x1 $\frac{1}{2}$ "	1	810109
75x2"	1	810127
110x1"	1	810123
110x1 $\frac{1}{2}$ "	1	810129
110x2"	1	810130
160x1"	1	810194
160x1 $\frac{1}{2}$ "	1	810189
160x2"	1	810132

ELEKTROMETINĀMIE VEIDGABALI **PE** CAURULĒM

Nosaukums	Izmērs	Iepak.	Kods
-----------	--------	--------	------

EM DUBULTUZMAVA PN16



D(mm)	gab.	
20	50	720505
25	50	720506
32	50	720507
40	50	720510
50	10	720513
63	10	720516
75	12	720519
90	10	720522
110	5	720525
125	5	720528
140	5	720531
160	6	720634
180	5	720637
200	2	720640
225	3	720643
250	2	720646
280	1	720649
315	1	720652
355	1	720655
400	1	720656

EM DUBULTUZMAVA PN10



D(mm)	gab.	
160	6	720534
180	4	720537
200	2	720540
225	3	720543
250	2	720546
280	1	720549
315	1	720552
355	1	720555
400	1	720556
450	1	720557
500	1	720558
560	1	720559
630	1	720560

EM REDUKCIJAS DUBULTUZMAVA PN16



D(mm)	gab.	
25 / 20	20	721018
32 / 20	20	721019
32 / 25	20	721020
40 / 32	20	721022
50 / 32	10	721021
50 / 40	15	721023
63 / 32	10	721025
63 / 40	10	721027
63 / 50	10	721030
90 / 63	12	721035
110 / 90	16	721040
125 / 90	6	721043
160 / 110	5	721045
180 / 125	4	721055
200 / 160	1	721060
225 / 160	1	721075
250 / 160	2	721080
250 / 200	2	721085

ELEKTROMETINĀMIE VEIDGABALI PE CAURULĒM

Nosaukums	Izmērs	Iepak.	Kods
-----------	--------	--------	------

EM TREJGABALS PN16

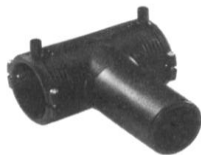

D(mm)	gab.	
20	10	722005
25	10	722006
32	10	722007
40	10	722010
50	5	722013
63	5	722016
75	0	722019
90	10	722022
110	5	722025
125	4	722028
160	3	722034
180	2	722037
200	1	722038
225	1	722039
250	1	722040

EM LĪKNIS 90° PN16



D(mm)	gab.	
20	10	723605
25	10	723606
32	10	723607
40	10	723610
50	10	723613
63	10	723616
75	33	723620
90	14	723622
110	10	723625
125	5	723628
160	4	723634
180	1	723635
200	1	723636
225	1	723637
250	1	723638

EM LĪKNIS 45° PN16



D(mm)	gab.	
32	20	723313
40	10	723314
50	10	723315
63	10	723316
75	0	723319
90	20	723322
110	6	723325
125	6	723328
160	5	723334
180	1	723335
200	1	723336
225	1	723337
250	1	723338

ELEKTROMETINĀMIE VEIDGABALI **PE** CAURULĒM

Nosaukums	Izmērs	Iepak.	Kods
-----------	--------	--------	------

EM NOSLĒGTAPA PN16



D(mm)	gab.	
20	50	DMN020
25	50	DMN025
32	50	DMN032
40	50	DMN040
50	10	DMN050
63	10	DMN063
75	6	DMN075
90	5	DMN090
110	3	DMN0110
125	3	DMN0125
140	3	DMN0140
160	2	DMN0160
180	1	DMN0180
200	2	DMN0200
225	4	DMN0225
250	1	DMN0250

EM SEDLU TREJGABALS PN16
ar maināmu pievienojuma leņķi



D(mm)	gab.	
63 / 32	3	722508
63 / 63	5	723554
75 / 32	3	722512
75 / 63	5	723555
90 / 32	3	722516
90 / 63	5	723556
110 / 32	3	722520
110 / 63	3	723560
125 / 32	3	722524
125 / 63	3	723562
140 / 32	3	722526
140 / 63	3	723564
160 / 32	3	722528
160 / 63	3	723568
180 / 32	5	722530
180 / 63	3	723572
200 / 32	3	722534
200 / 63	3	723576
225 / 32	3	722538
225 / 63	3	723580
250 / 32	3	722540
250 / 63	3	723584

EM SEDLU TREJGABALS PN16
ar fiksētu pievienojuma leņķi



D(mm)	gab.	
63 / 32	3	722509
90 / 32	3	722517
110 / 32	3	722521
110 / 63	3	723561
125 / 32	3	722525
160 / 32	3	722529
160 / 63	3	723569

ELEKTROMETINĀMIE VEIDGABALI PE CAURULĒM

Nosaukums	Izmērs	Iepak.	Kods
-----------	--------	--------	------

ĪSCAURULE AR ATLOKU UN GREDZENU PN10

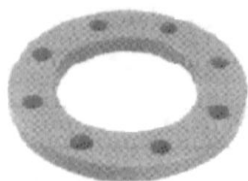

D(mm)	gab.	
50 / 40	1	DMI050
63 / 50	1	DMI063
75 / 65	1	DMI075
90 / 80	1	DMI090
110 / 100	1	DMI0110
125 / 100	1	DMI0125
140 / 125	1	DMI0140
160 / 150	1	DMI0160
180 / 150	1	DMI0180
200 / 200	1	DMI0200
225 / 200	1	DMI0225
250 / 250	1	DMI0250
280 / 250	1	DMI0280
315 / 300	1	DMI0315
355 / 350	1	DMI0355
400 / 400	1	DMI0400
450 / 500	1	DMI0450
500 / 500	1	DMI0500
560 / 600		DMI0560
630 / 600		DMI0630

PE KONTAKTMETINĀMĀ REDUKCIJA PN10



D(mm)	gab.	
75 / 63	1	DMR07563
90 / 63	1	DMR09063
90 / 75	1	DMR09075
110 / 63	1	DMR01163
110 / 90	1	DMR01190
125 / 90	1	DMR01290
125 / 110	1	DMR01211
140 / 125	1	DMR01412
160 / 90	1	DMR01690
160 / 110	1	DMR01610
160 / 125	1	DMR01612
160 / 140	1	DMR01614
180 / 90	1	DMR01890
180 / 110	1	DMR01811
180 / 125	1	DMR01812
180 / 160	1	DMR01816
200 / 160	1	DMR02016
200 / 180	1	DMR02018
225 / 160	1	DMR02216
225 / 180	1	DMR02218
225 / 200	1	DMR02220
250 / 160	1	DMR02516
250 / 200	1	DMR02520
250 / 225	1	DMR02522
280 / 225	1	DMR02822
280 / 250	1	DMR02825
315 / 200	1	DMR03120
315 / 225	1	DMR03122
315 / 250	1	DMR03125

ELEKTROMETINĀMIE VEIDGABALI PE CAURULĒM

Nosaukums	Izmērs	Iepak.	Kods
-----------	--------	--------	------

PE KONTAKTMETINĀMAIS LĪKNIS PN10



D(mm)	gab.	
110 / 5° ... 30°	1	SML01102
125 / 5° ... 30°	1	SML01252
140 / 5° ... 30°	1	SML01402
160 / 5° ... 30°	1	SML01602
180 / 5° ... 30°	1	SML01802
200 / 5° ... 30°	1	SML02002
225 / 5° ... 30°	1	SML02252
250 / 5° ... 30°	1	SML02502
280 / 5° ... 30°	1	SML02802
315 / 5° ... 30°	1	SML03152
355 / 5° ... 30°	1	SML03552
400 / 5° ... 30°	1	SML04002



D(mm)	gab.	
110 / 31° ... 60°	1	SML01104
125 / 31° ... 60°	1	SML01254
140 / 31° ... 60°	1	SML01404
160 / 31° ... 60°	1	SML01604
180 / 31° ... 60°	1	SML01804
200 / 31° ... 60°	1	SML02004
225 / 31° ... 60°	1	SML02254
250 / 31° ... 60°	1	SML02504
280 / 31° ... 60°	1	SML02804
315 / 31° ... 60°	1	SML03154
355 / 31° ... 60°	1	SML03554
400 / 31° ... 60°	1	SML04004



D(mm)	gab.	
110 / 61° ... 90°	1	SML01106
125 / 61° ... 90°	1	SML01256
140 / 61° ... 90°	1	SML01406
160 / 61° ... 90°	1	SML01606
180 / 61° ... 90°	1	SML01806
200 / 61° ... 90°	1	SML02006
225 / 61° ... 90°	1	SML02256
250 / 61° ... 90°	1	SML02506
280 / 61° ... 90°	1	SML02806
315 / 61° ... 90°	1	SML03156
355 / 61° ... 90°	1	SML03556
400 / 61° ... 90°	1	SML04006

SPIEDVADU SISTĒMA PVC

Nosaukums	Izmērs	Iepak	Kods
-----------	--------	-------	------

PVC SPIEDVADU CAURULE AR UZMAVU PN10 D_a (mm) s (mm) L (m) gab.

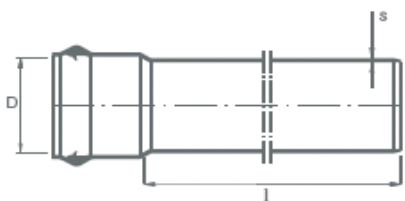

90	4.3	6	50	030203
110	4.2	6	35	030510
160	6.2	6	20	030515
225	8.6	6	8	030520
280	13.4	6	6	030210
315	15.0	6	6	030211
400	19.1	6	3	030213

PVC DUBULTUZMAVA PN10

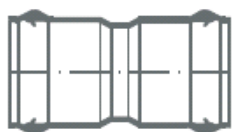

D(mm) gab.

90	1	040733
110	1	040734
160	1	040736
225	1	040737
280	1	040738
315	1	040739

PVC LABOŠANAS DUBULTUZMAVA PN10



D(mm) gab.

90	1	040703
110	1	040704
160	1	040706
225	1 *	040707
280	1 *	040708
315	1 *	040709
400	1 *	040710

* - pēc pasūtījuma

SPIEDVADU SISTĒMA PVC

Nosaukums	Izmērs	Iepak	Kods
-----------	--------	-------	------

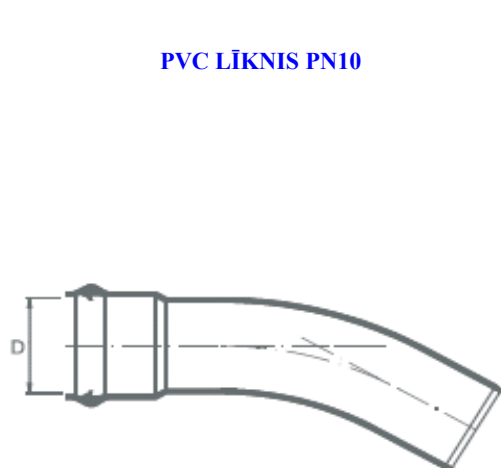

	D _g (mm)	gab.	Kods
90	/ 11°	1	040003
	/ 22°	1	040103
	/ 30°	1	040203
	/ 45°	1	040303
	/ 60°	1	040403
	/ 90°	1	040503
110	/ 11°	1	040004
	/ 22°	1	040104
	/ 30°	1	040204
	/ 45°	1	040304
	/ 60°	1	040404
	/ 90°	1	040504
160	/ 11°	1	040006
	/ 22°	1	040106
	/ 30°	1	040206
	/ 45°	1	040306
	/ 60°	1	040406
	/ 90°	1	040506
225	/ 11°	1 *	040007
	/ 22°	1 *	040107
	/ 30°	1 *	040207
	/ 45°	1 *	040307
	/ 60°	1 *	040407
	/ 90°	1 *	040507
280	/ 11°	1 *	040008
	/ 22°	1 *	040108
	/ 30°	1 *	040208
	/ 45°	1 *	040308
	/ 60°	1 *	040408
	/ 90°	1 *	040508
315	/ 11°	1 *	040009
	/ 22°	1 *	040109
	/ 30°	1 *	040209
	/ 45°	1 *	040309
	/ 60°	1 *	040409
	/ 90°	1 *	040509
400	/ 11°	1 *	040010
	/ 22°	1 *	040110
	/ 30°	1 *	040210
	/ 45°	1 *	040310
	/ 60°	1 *	040410
	/ 90°	1 *	040510

* - pēc pasūtījuma